

Silicon Dual Diode

BYV42F-200

200V/20A

DATASHEET

OEM – Philips

Source: Philips Databook 1999

Rectifier diodes ultrafast, rugged

BYV42F, BYV42EX series

FEATURES

- Low forward volt drop
- Fast switching
- Soft recovery characteristic
- Reverse surge capability
- High thermal cycling performance
- Isolated mounting tab

SYMBOL

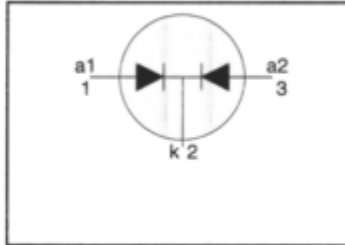

QUICK REFERENCE DATA

$$V_R = 150 \text{ V} / 200 \text{ V}$$

$$V_F \leq 0.9 \text{ V}$$

$$I_{O(AV)} = 20 \text{ A}$$

$$I_{RRM} = 0.2 \text{ A}$$

$$t_{tr} \leq 28 \text{ ns}$$

GENERAL DESCRIPTION

Dual, ultra-fast, epitaxial rectifier diodes intended for use as output rectifiers in high frequency switched mode power supplies.

The BYV42F series is supplied in the SOT186 package.
The BYV42EX series is supplied in the SOT186A package.

PINNING

PIN	DESCRIPTION
1	anode 1 (a)
2	cathode (k)
3	anode 2 (a)
tab	isolated

SOT186

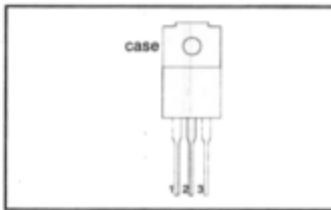

SOT186A

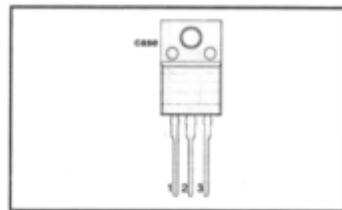

LIMITING VALUES

Limiting values in accordance with the Absolute Maximum System (IEC 134).

SYMBOL	PARAMETER	CONDITIONS	MIN.		MAX.		UNIT
		BYV42F / BYV42EX					
V_{RRM}	Peak repetitive reverse voltage		-	-150	-200		V
V_{RWM}	Crest working reverse voltage		-	150	200		V
V_R	Continuous reverse voltage	$T_{ns} \leq 125^\circ\text{C}$	-	150	200		V
$I_{O(AV)}$	Average rectified output current (both diodes conducting) ¹	square wave $\delta = 0.5$; $T_{ns} \leq 78^\circ\text{C}$	-	20			A
I_{FRM}	Repetitive peak forward current per diode	$t = 25 \mu\text{s}$; $\delta = 0.5$; $T_{ns} \leq 78^\circ\text{C}$	-	30			A
I_{FSM}	Non-repetitive peak forward current per diode	$t = 10 \text{ ms}$ $t = 8.3 \text{ ms}$ sinusoidal; with reappled	-	150	160		A
I_{RRM}	Repetitive peak reverse current per diode	$V_{RWM(max)}$ $t_p = 2 \mu\text{s}$; $\delta = 0.001$	-	0.2			A
I_{RSM}	Non-repetitive peak reverse current per diode	$t_p = 100 \mu\text{s}$	-	0.2			A
T_{stg}	Storage temperature		-40	150			$^\circ\text{C}$
T_j	Operating junction temperature		-	150			$^\circ\text{C}$

¹ Neglecting switching and reverse current losses.

Rectifier diodes
ultrafast, rugged

BYV42F, BYV42EX series

ESD LIMITING VALUE

SYMBOL	PARAMETER	CONDITIONS	MIN.	MAX.	UNIT
V_C	Electrostatic discharge capacitor voltage	Human body model; $C = 250 \text{ pF}$; $R = 1.5 \text{ k}\Omega$	-	8	kV

ISOLATION LIMITING VALUE & CHARACTERISTIC

$T_{hs} = 25 \text{ }^\circ\text{C}$ unless otherwise specified

SYMBOL	PARAMETER	CONDITIONS	MIN.	TYP.	MAX.	UNIT
V_{isol}	R.M.S. isolation voltage from all three terminals to external heatsink	SOT186A package; $f = 50\text{-}60 \text{ Hz}$; sinusoidal waveform; R.H. $\leq 65\%$; clean and dustfree	-		2500	V
V_{isol}	Repetitive peak voltage from all three terminals to external heatsink	SOT186 package; R.H. $\leq 65\%$; clean and dustfree	-		1500	V
C_{isol}	Capacitance from pin 2 to external heatsink	$f = 1 \text{ MHz}$	-	10	-	pF

THERMAL RESISTANCES

SYMBOL	PARAMETER	CONDITIONS	MIN.	TYP.	MAX.	UNIT
$R_{th(j-hs)}$	Thermal resistance junction to heatsink	both diodes conducting with heatsink compound without heatsink compound per diode	-	-	4.0 8.0	K/W K/W
$R_{th(j-a)}$	Thermal resistance junction to ambient	with heatsink compound without heatsink compound in free air	-	-	5.0 9.0	K/W K/W
			-	55	-	K/W

ELECTRICAL CHARACTERISTICS

characteristics are per diode at $T_j = 25 \text{ }^\circ\text{C}$ unless otherwise stated

SYMBOL	PARAMETER	CONDITIONS	MIN.	TYP.	MAX.	UNIT
V_F	Forward voltage	$I_F = 15 \text{ A}$; $T_j = 150 \text{ }^\circ\text{C}$	-	0.83	0.90	V
		$I_F = 15 \text{ A}$	-	0.95	1.05	V
		$I_F = 30 \text{ A}$	-	1.00	1.20	V
I_R	Reverse current	$V_R = V_{RWM}$; $T_j = 100 \text{ }^\circ\text{C}$	-	0.5	1	mA
		$V_R = V_{RWM}$	-	10	100	μA
Q_s	Reverse recovery charge	$I_F = 2 \text{ A}$; $V_R \geq 30 \text{ V}$; $-di_F/dt = 20 \text{ A}/\mu\text{s}$	-	6	15	nC
t_{rr1}	Reverse recovery time	$I_F = 1 \text{ A}$; $V_R \geq 30 \text{ V}$; $-di_F/dt = 100 \text{ A}/\mu\text{s}$	-	20	28	ns
t_{rr2}	Reverse recovery time	$I_F = 0.5 \text{ A}$ to $I_R = 1 \text{ A}$; $I_{rec} = 0.25 \text{ A}$	-	13	22	ns
I_{rrm}	Peak reverse recovery current	$I_F = 10 \text{ A}$; $V_R \geq 30 \text{ V}$; $-di_F/dt = 50 \text{ A}/\mu\text{s}$; $T_j = 100 \text{ }^\circ\text{C}$	-	2	2.4	A
V_r	Forward recovery voltage	$I_F = 1 \text{ A}$; $di_F/dt = 10 \text{ A}/\mu\text{s}$	-	1	-	V

Rectifier diodes
ultrafast, rugged

BYV42F, BYV42EX series

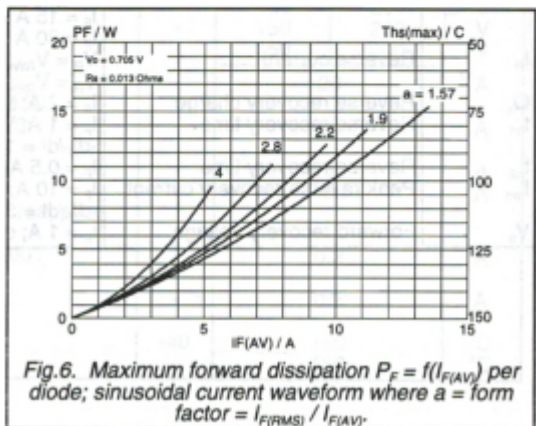
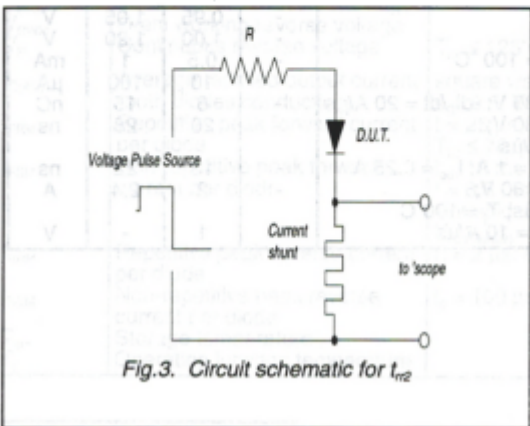
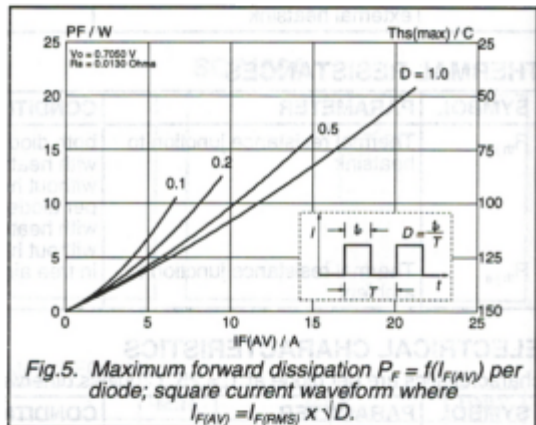
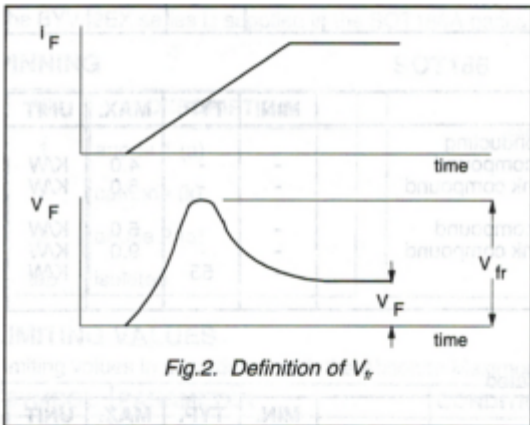
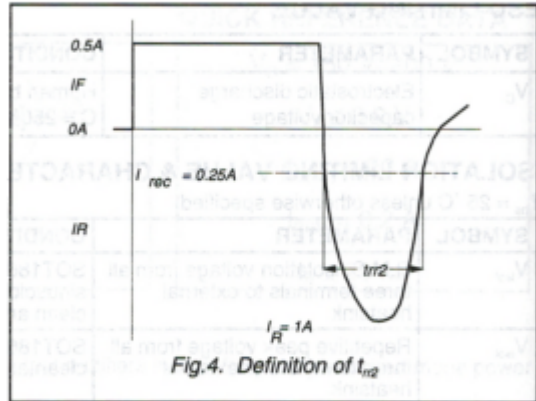
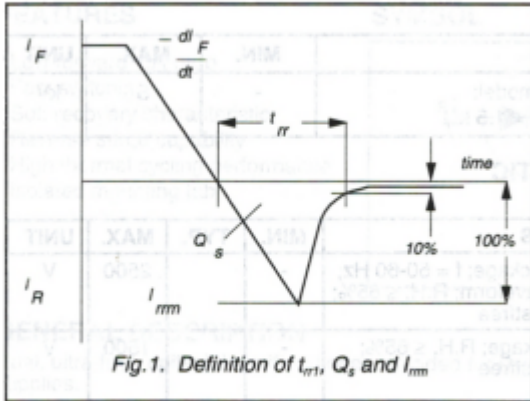

Rectifier diodes
ultrafast, rugged

BYV42F, BYV42EX series

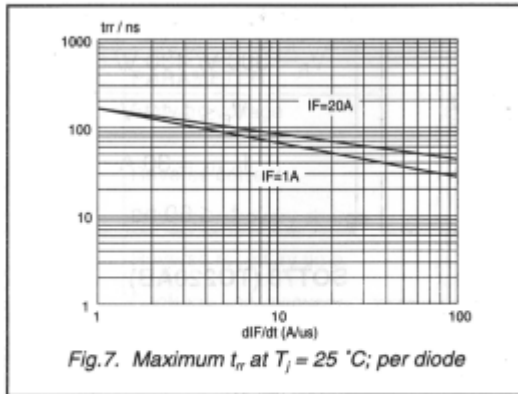

Fig.7. Maximum t_{rr} at $T_j = 25^\circ C$; per diode

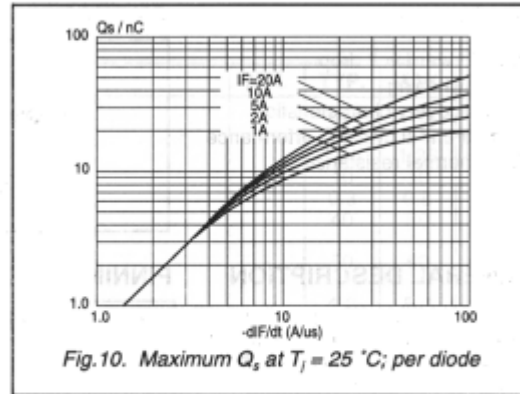

Fig.10. Maximum Q_s at $T_j = 25^\circ C$; per diode

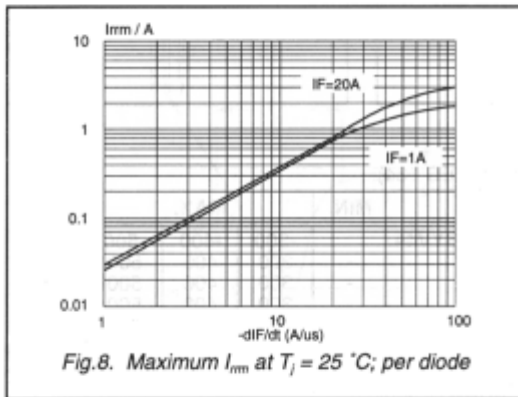

Fig.8. Maximum I_{rrm} at $T_j = 25^\circ C$; per diode

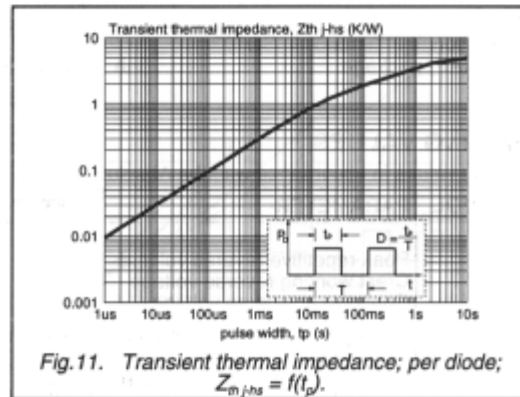

Fig.11. Transient thermal impedance; per diode;
 $Z_{th(j-hs)} = f(t_p)$.

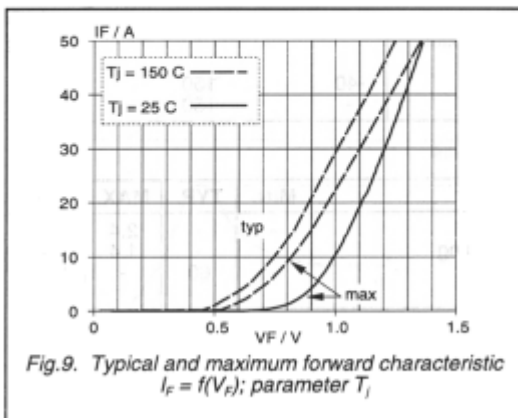

Fig.9. Typical and maximum forward characteristic
 $I_f = f(V_f)$; parameter T_j