

Silicon – Diode Array

FSA2619P

8 Diode Array

100V/350mA

DATASHEET

OEM – Fairchild

Source: Fairchild Databook 1978

**FSA2619M • FSA2619P • FSA2620M • FSA2620P
FSA2621M • FSA2719M • FSA2719P • FSA2720M
FSA2720P • FSA2721M**

PLANAR AIR-ISOLATED MONOLITHIC DIODE ARRAYS

- C... 2.0 pF (MAX) FSA2719 Series
- ΔV_F ... 15 mV (MAX) @ 10 mA

ABSOLUTE MAXIMUM RATINGS (Notes 1 and 5)

Temperatures

Storage Temperature Range (M Suffix) (P Suffix)	-55° C to +200° C
Maximum Junction Operating Temperature	-55° C to +150° C
Lead Temperature	+150° C +260° C

Power Dissipation (Note 2)

Maximum Dissipation per Junction at 25° C Ambient	400 mW
Maximum Dissipation per Package at 25° C Ambient	650 mW
Linear Derating factor (from 25° C) Junction	3.2 mW / °C
Package	5.2 mW / °C

Maximum Voltage and Currents

WIV	Working Inverse Voltage FSA2619 (Note 5) FSA2719	75 V 50 V
I_F	Continuous Forward Current	350 mA
I_F (surge)	Peak Forward Surge Current Pulse Width = 1.0 s Pulse Width = 1.0 μ s	1.0 A 2.0 A

CONNECTION DIAGRAMS

FSA2619 • FSA2719

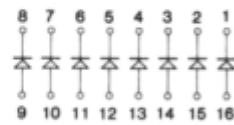

See Package Outlines

6B (Ceramic DIP)	FSA2619M FSA2719M
9B (Plastic DIP)	FSA2619P FSA2719P

ELECTRICAL CHARACTERISTICS (25° C Ambient Temperature unless otherwise noted)

SYMBOL	CHARACTERISTIC	MIN	MAX	UNITS	TEST CONDITIONS
BV	Breakdown Voltage (Note 5)	75		V	$I_R = 5.0 \mu A$ $I_R = 100 \mu A$
I_R	Reverse Current		5.0 25 50 100 100	μA nA μA nA μA	$V_R = 75 V$ $V_R = 20 V$ $V_R = 20 V, T_A = 150^\circ C$ $V_R = 50 V$ $V_R = 50 V, T_A = 150^\circ C$
V_F	Forward Voltage (Note 3)		1.0	V	$I_F = 10 mA$
t_{rr}	Reverse Recovery Time (Note 6)		5.0 6.0	ns	$I_F = I_R = 10 mA, t_{rr} = 1.0 mA$ $I_F = I_R = 10 mA, t_{rr} = 1.0 mA$
C	Capacitance (Note 6)		4.0 2.0	pF pF	$V_R = 0$ $V_R = 0$
ΔV_F	Forward Voltage Match (Note 6)		15	mV	$I_F = 10 mA$
t_{fr}	Forward Recovery Time (Note 6)		20	ns	50 mA Peak square wave, 0.1 μs Pulse Width, 5.0 kHz - 100 kHz
V_{FM}	Peak Forward Voltage (Note 6)		3.0	V	$I_F = 100 mA, t_r \leq 10 ns$
RE	Rectification Efficiency	45		%	$V_I = 2 V rms, f = 100 MHz$

NOTES:

- These ratings are limiting values above which life or satisfactory performance may be impaired.
- These are steady state limits. The factory should be consulted or applications involving pulsed or low duty-cycle operation.
- V_F is measured using an 8 ns pulse.
- See test circuits (Note 6) for measurement of reverse current of an individual diode.
- FSA2619 denotes series FSA2619M/P, FSA2620M/P and FSA2621M.
FSA2719 denotes series FSA2719M/P, FSA2720M/P and FSA2721M.
- For product family characteristics curves and test circuits, refer to Chapter 4, D15.

*UNCONNECTED

FAIRCHILD • DIODE ARRAYS

TO-86 OUTLINE

NOTES:
 Alloy 42 Leads, tin plated
 Gold plated leads available
 Hermetically sealed ceramic package
 Dot or tab indicates lead 1
 Package weight is 0.27 gram

FSA2620 • FSA2621 FSA2720 • FSA2721

See Package Outlines

TO-116-2 (Ceramic)	FSA2620M
	FSA2720M
TO-116 (Plastic)	FSA2620P
	FSA2720P
TO-86	FSA2621M
	FSA2721M

6B OUTLINE

NOTES:
 Alloy 42 pins, tin plated
 Gold plated pins available
 Hermetically sealed ceramic package
 Pins are intended for insertion in hole rows on .300" centers (7.62)
 They are purposely shipped with "positive" misalignment to facilitate insertion
 Board-drilling dimensions should equal your practice for .020 inch diameter pin (0.51)
 Package weight is 2.0 grams
 *The .037-.027 dimension does not apply to the corner pins

9B OUTLINE

NOTES:
 Alloy 42 pins, tin plated
 Gold plated pins available
 Transfer moulded DM-6B plastic package
 Pins are intended for insertion in hole rows on .300" (7.62) centers
 Leads purposely have a "positive" misalignment to facilitate insertion
 Board-drilling dimensions should equal your practice for .020 inch (0.51) diameter pin
 *** The .037-.027 (0.94-0.69) dimension does not apply to the corner pins

FAIRCHILD • ZENER DIODES

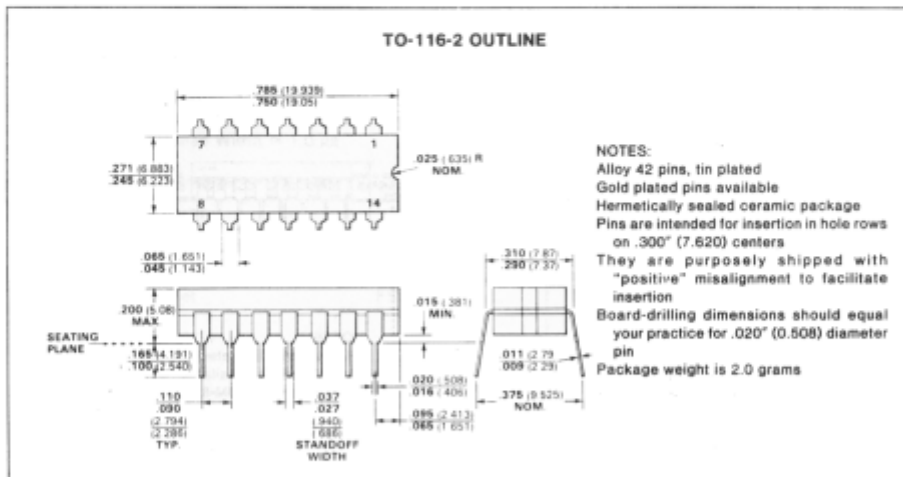
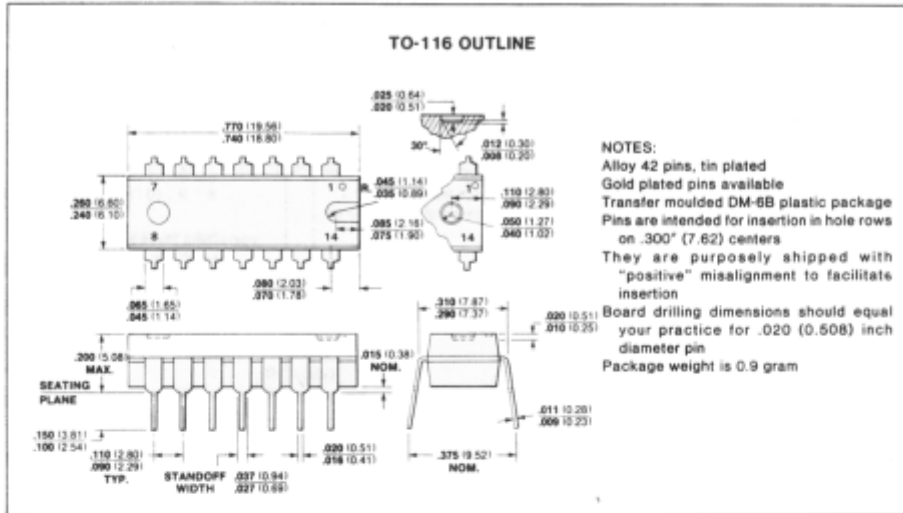

CURVE SET NUMBER D15
AIR-ISOLATED MONOLITHIC DIODE ARRAY

TYPICAL ELECTRICAL CHARACTERISTIC CURVES
 AT 25°C AMBIENT TEMPERATURE UNLESS OTHERWISE NOTED

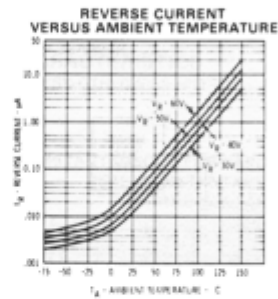
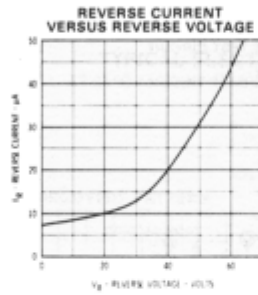
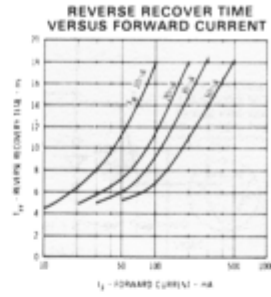
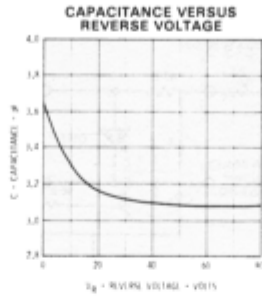
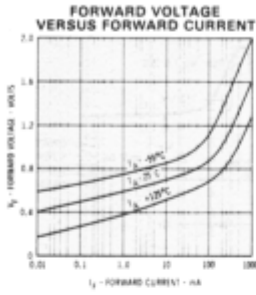

TEST CIRCUITS

To measure reverse current of an individual diode, the following test circuits are used:

COMMON CATHODE DIODES

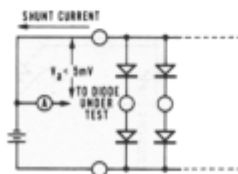

COMMON ANODE DIODES

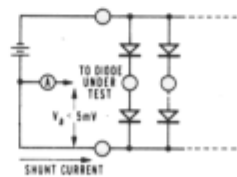

CURVE SET NUMBER D15
AIR-ISOLATED MONOLITHIC DIODE ARRAY

TEST CIRCUITS

Test requirement for V_{FM} and t_{rr} is as shown below; all leads should be as short as possible.

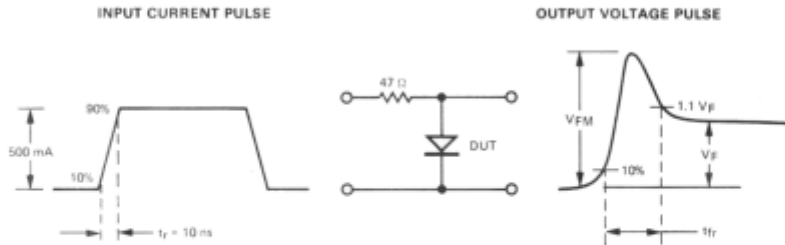

t_{rr} - REVERSE RECOVERY TIME TEST CIRCUIT
 $I_f = I_r, I_{rr} = 0.1 I_f$

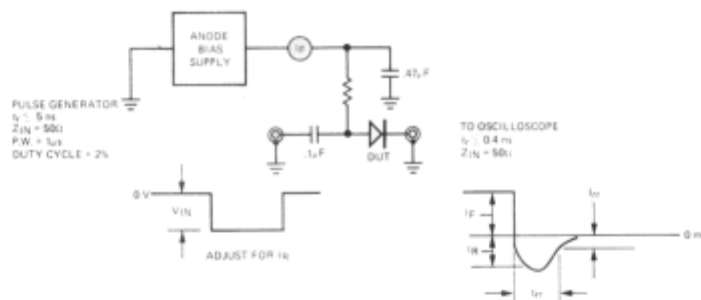

ΔV_F BRIDGE MATCHING CIRCUIT

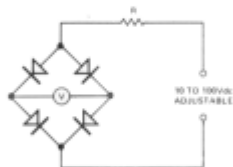

ΔI_R BRIDGE MATCHING CIRCUIT

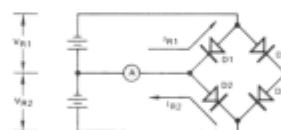

NOTES:

1. R Varies depending on the current range. For the most often used current ranges, R is as follows:

Current Range (amperes)	R (ohms)
10^{-5} to 10^{-4}	10^6
10^{-4} to 10^{-3}	10^5
10^{-3} to 10^{-2}	10^4
or 10^{-n} to 10^{-n+1}	10^{n+1}

2. V indicates mismatch of assembly.

NOTES:

- $V_{R2} = V_{R1} \pm 1\%$.
- $I_{R2} - I_{R1} = \Delta I_R$ (difference in I_R between diodes D1 & D2). To measure diodes D3 & D4, reverse cathode-anode terminal connections.
- A is a center reading pico ammeter. ΔI_R indicated directly on A.