

Schottky Diode

MBRF750

50V / 7,5A

DATASHEET

from

www.web-bcs.com

OEM – General Semiconductor

Source: General Semiconductor Databook 1998

NEW PRODUCT

NEW PRODUCT

NEW PRODUCT

MBRF735 THRU MBRF760

SCHOTTKY RECTIFIER

Reverse Voltage - 35 to 60 Volts Forward Current - 7.5 Amperes

ITO-220AC

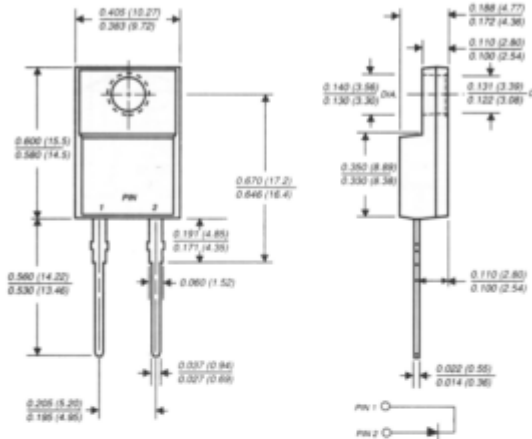

Dimensions in inches and (millimeters)

FEATURES

- ◆ Plastic package has Underwriters Laboratory Flammability Classifications 94V-0
- ◆ Metal to silicon rectifier, majority carrier conduction
- ◆ Low power loss, high efficiency
- ◆ High current capability, low forward voltage drop
- ◆ High surge capability
- ◆ For use in low voltage, high frequency inverters, free wheeling, and polarity protection applications
- ◆ Guardring for overvoltage protection
- ◆ High temperature soldering guaranteed: 250°C/10 seconds, 0.25" (6.35mm) from case



MECHANICAL DATA

Case: JEDEC ITO-220AC molded plastic body

Terminals: Lead solderable per MIL-STD-750, Method 2026

Polarity: As marked

Mounting Position: Any

Mounting Torque: 5 in. - lbs. max.

Weight: 0.08 ounces, 2.24 grams

MAXIMUM RATINGS AND ELECTRICAL CHARACTERISTICS

Ratings at 25°C ambient temperature unless otherwise specified.

	SYMBOLS	MBRF735	MBRF745	MBRF50	MBRF760	UNITS
Maximum repetitive peak reverse voltage	VRRM	35	45	50	60	Volts
Maximum working peak reverse voltage	VRWM	35	45	50	60	Volts
Maximum DC blocking voltage	VDC	35	45	50	60	Volts
Maximum average forward rectified current (SEE FIG 1)	IAV	7.5				Amps
Peak repetitive forward current (square wave, 20 KHz) at TC=105°C	IFRM	15.0				Amps
Peak forward surge current, 8.3ms single half sine-wave superimposed on rated load (JEDEC Method)	IFSM	150.0				Amps
Peak repetitive reverse surge current (NOTE 1)	IRRM	1.0		0.5		Amps
Maximum instantaneous forward voltage at (NOTE 2)	VF	0.57		0.65		Volts
		0.84		-		
		0.72		-		
Maximum instantaneous reverse current at rated DC blocking voltage (NOTE 1)	IR	0.1		0.5		mA
		15.0		1000		
Voltage rate of change (rated VR)	dv/dt	10,000		1000		V/μs
Maximum thermal resistance, (NOTE 3)	REJC	5.0				°C/W
Operating junction temperature range	TJ	-65 to +150				°C
Storage temperature range	TSTG	-65 to +175				°C

NOTES: (1) 2.0μs, pulse width, f=1.0 KHz

(2) Pulse test: 300μs pulse width, 1% duty cycle

(3) Thermal resistance from junction to case and/or thermal resistance from junction to ambient

RATINGS AND CHARACTERISTIC CURVES MBRF735 THRU MBRF760

