

Silicon Diode

1N3614

800V / 1A

DATASHEET

OEM – Unitrode

Source: Unitrode Databook 1989-1990

RECTIFIERS

Military Approved, 1 Amp,
General Purpose

JAN & JANTX 1N3611-1N3614

FEATURES

- Qualified to MIL-S-19500/228
- Continuous Rating: 1A
- Surge Rating: 30A
- PIV: to 800V

DESCRIPTION

This series of MIL approved JAN and JANTX general purpose 1 amp rectifiers are useful in many high rel applications.

ABSOLUTE MAXIMUM RATINGS

Peak Reverse Voltage Min.	Reverse Working Voltage	Type
240V	200V	JAN & JANTX 1N3611
480V	400V	JAN & JANTX 1N3612
720V	600V	JAN & JANTX 1N3613
920V	800V	JAN & JANTX 1N3614

Maximum Average D.C. Output Current
 @ $T_A = 100^\circ\text{C}$ 1.0A
 @ $T_A = 150^\circ\text{C}$ 0.3A
 Non-Repetitive Sinusoidal
 Surge Current (8.3ms) 30A
 Operating Temperature Range -65°C to $+175^\circ\text{C}$
 Storage Temperature Range -65°C to $+200^\circ\text{C}$
 Thermal Resistance See Lead Temperature Derating Curve

MECHANICAL SPECIFICATIONS

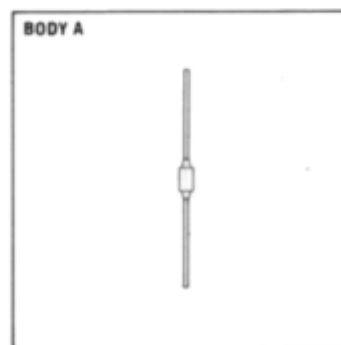
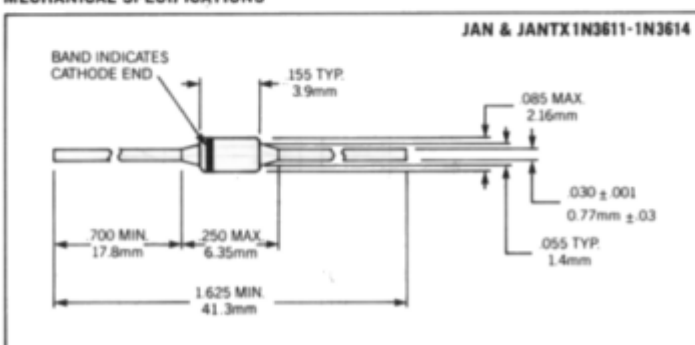

THESE DEVICES ALSO AVAILABLE IN SURFACE MOUNT PACKAGE. SEE SECTION 11.

JAN & JANTX 1N3611- 1N3614

ELECTRICAL SPECIFICATIONS (at 25°C unless noted)

Type	Peak Reverse D.C. Voltage	Minimum Reverse Breakdown Voltage @ 100µA	Peak Forward Voltage		Maximum D.C. Reverse Current at D.C. Voltage	
			Min.	Max.	25°C	150°C
JAN & JANTX 1N3611	200V	240V	0.6V @ 1.0A	1.1V(pk)	1µA	300µA
JAN & JANTX 1N3612	400V	480V				
JAN & JANTX 1N3613	600V	720V				
JAN & JANTX 1N3614	800V	920V				

